

PARTS DIAGRAM

ENDURA C2 50 50 LBS THRUST - 12 VOLT - 36"/42" SHAFT

This page provides Minn Kota® WEEE compliance disassembly instructions. For more information about where you should dispose of your waste equipment for recycling and recovery and/or your European Union member state requirements, please contact your dealer or distributor from which your product was purchased.

Tools required, but not limited to: flat head screw driver, Phillips screw driver, socket set, pliers, wire cutters.

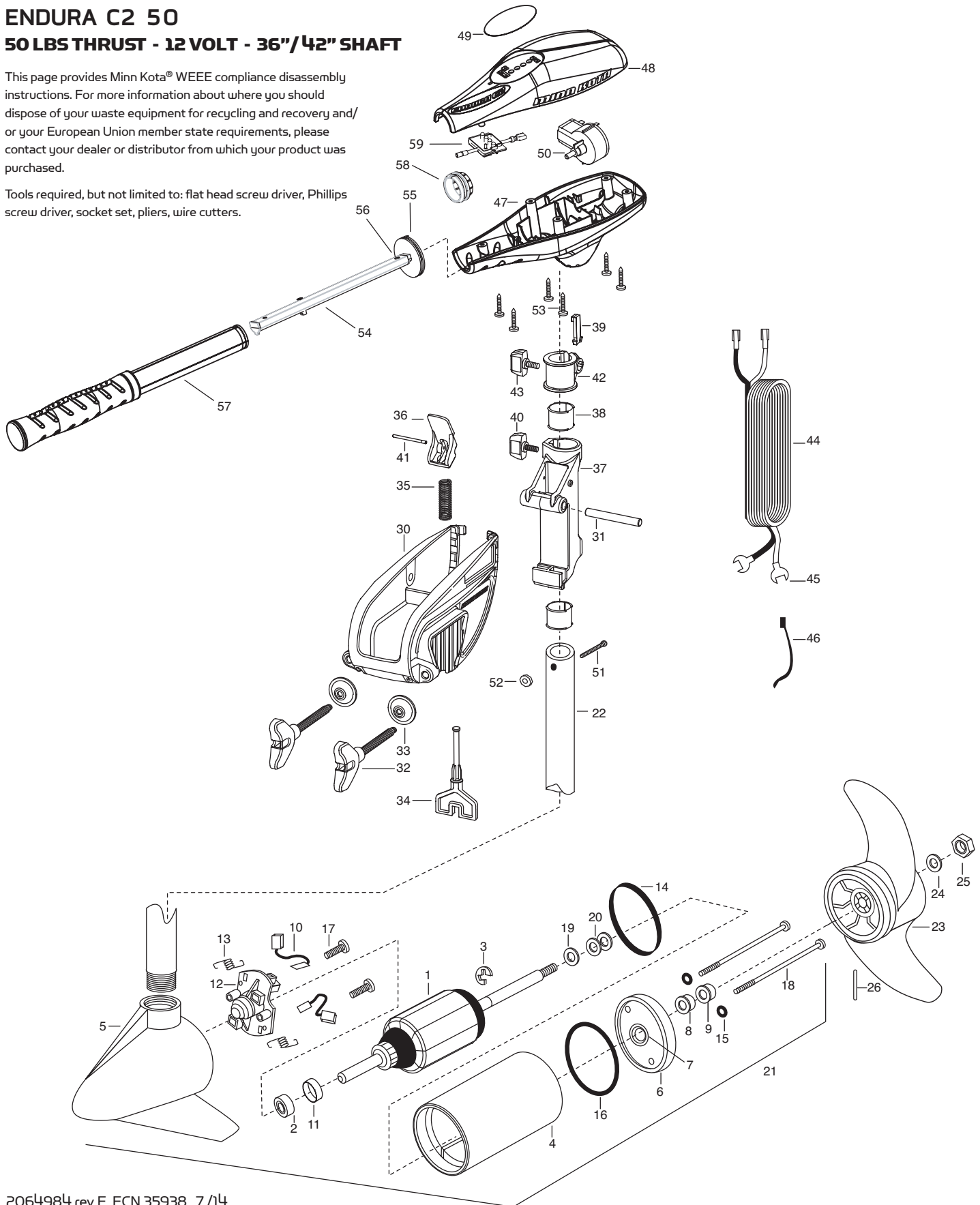

PARTS LIST

ENDURA C2 50

50 LBS THRUST - 12 VOLT - 36"/42" SHAFT

ITEM	QTY	PART NUMBER	DESCRIPTION
1	1	2-100-121	ARMATURE ASSEMBLY 12V 3.62
2	1	140-010	RADIAL BEARING
3	1	788-015	RETAINING RING
4	1	2-200-101	CENTER HOUSING ASSEMBLY
5	1	2-300-196	BRUSH END HOUSING ASSEMBLY 3.62 SPCO 36"
	1	2-300-195	BRUSH END HOUSING ASSEMBLY 3.62 SPCO 42"
6	1	2-400-101	PLAIN END HOUSING ASSEMBLY
7	1	144-049	FLANGE BEARING (SERVICE ONLY)
8	1	880-003	SEAL
9	1	880-006	SEAL W/SHIELD
10	2	188-036	BRUSH ASSEMBLY
11	1	725-050	BRUSH RETENTION – PAPER TUBE
12	1	738-036	BRUSH PLATE WITH HOLDER
13	2	975-040	TORSION SPRING
14	1	337-036	GASKET
15	2	701-008	O-RING
16	1	701-081	O-RING
17	2	830-007	SCREW – #8-32
18	2	830-042	THRU BOLT #10-32X8.83
19	1	990-067	WASHER – STEEL THRUST
20	2	990-070	WASHER – NYLATRON
21	1	2097035	MOTOR ASSEMBLY 12V 3.62 55PC FW 36"
	1	2097036	MOTOR ASSEMBLY 12V 3.62 55PC FW 42"
22	1	2032046	36" COMPOSITE TUBE
	1	2032047	42" COMPOSITE TUBE
■	1	1378170	PROPELLER KIT (INCLUDES 23-26)
23	1	2091170	POWER PROPELLER 3-5/8"
24	1	2151726	WASHER – 5/16 STD SS
25	1	2053101	NUT – NYLOC 5/16
26	1	2092600	DRIVE PIN
■	1	2771818	BRACKET & HINGE ASSEMBLY (INCLUDES 30-41)
■	1	2771910	BRACKET ASSEMBLY (INCLUDES 30, 32, 33)

ITEM	QTY	PART NUMBER	DESCRIPTION
*30	1	2061910	BRACKET
31	1	2060510	HINGE PIN
■	2	2881300	SCREW – CLAMP, WASHER, RETAINER KIT
*32	2	2061300	SCREW – CLAMP
*33	2	2011710	WASHER – CLAMP
34	1	2063605	PLASTIC T-BAR
35	1	2062706	T-BAR SPRING
36	1	2067201	BLACK TILT LEVER
37	1	2061810	PLASTIC HINGE
38	2	2037301	HINGE BUSHING
39	1	2062800	SNAP-IN TENSION BLOCK
40	1	2011385	SCREW – TENSION/KNOB
41	1	2060515	TILT LEVER PIN
42	1	2061520	DEPTH COLLAR
43	1	2011365	SCREW – COLLAR/NEW KNOB
44	1	2050631	LEADWIRE 10 GA SPADE TERM
45	2	2020702	SPADE TERMINAL 10GA.
46	2	2256300	TIE WRAP
47	1	2062515	CONTROL BOX
48	1	2060215	CONTROL BOX COVER
49	1	2065724	DECAL COVER ENDURA C2 50
50	1	2064028	SWITCH – FWD/REV 5 SP
51	1	2033401	SCREW – #10-24 X 1-3/4
52	1	2013110	NUT – 10-24 HEX
53	6	2012100	SCREW – #8-18 X 5/8
54	1	2990919	INNER HANDLE ASSEMBLY
55	1	2060405	HANDLE PIVOT
56	1	2012102	SCREW – #6 X 1/2" SS
57	1	2990928	OUTER HANDLE ASSEMBLY
58	1	2060009	FRONT BEARING
59	1	2074070	BATTERY METER
■	1	2888460	SEAL AND O-RING KIT

■ THIS ITEM IS PART OF AN ASSEMBLY.

*THIS ITEM IS PART OF A KIT AND ONLY LISTED FOR VIEWING PURPOSES.